



SPIERINGS
MOBILE CRANES

Make: SPIERINGS Type: SK498-AT4

Crane specification

Serial Number **498xxx**
Year of Construction **2009**

Crane group : 3 as per NEN 2018
Loadspectrum : 2 as per NEN 2018
Classification : A as per NEN 2018
Stability : as per NEN 2022

Max. load 8,0 tonne	Max. radius with max. load 12,85 m	Max. capacity 103 tm	Max. jib length 44 m
-------------------------------	--	--------------------------------	--------------------------------

Speed		Jib horizontal / jib 30° luffed	
m/min	kg		
18	8000		0 - 70 m/min
27	4000		
40	2000		0-0,9 rpm
60	0		

All motions with hydraulic proportional controls.
Luffing the jib 30° can be controlled from crane cab or by remote control.
The crane should be folded in at wind force 9 (Bf) (21 m/sec) or when not in use for a longer period.

Counterweight crane: 9500 kg.
Continues slewing (360°) with outriggers out and support pads down.
Crane can be driven in its erected position under special conditions (refer user guide).

Rated lift capacity is net capacity.
Always two parts of line.
Max. line pull force: 4000 kg.
Operating temperature range from: -15°C till + 40°C.
Sail area of the load max.: 1,0 m²/ton.

Outrigger positioned according to lifting chart
Outrigger support base : 6,925 m x 6,85 m.
Operation allowed up to wind force 8 Bf (17 m/sec).
Outrigger support base : 6,925 m x 5,15 m.
Operation allowed up to wind force 8 Bf (17 m/sec).
Max. outrigger force: 380 kN.

LIFTING CHART outrigger support base 6,925 m x 6,85 m up to wind force 8 on the Beaufort scale (17 m/sec)

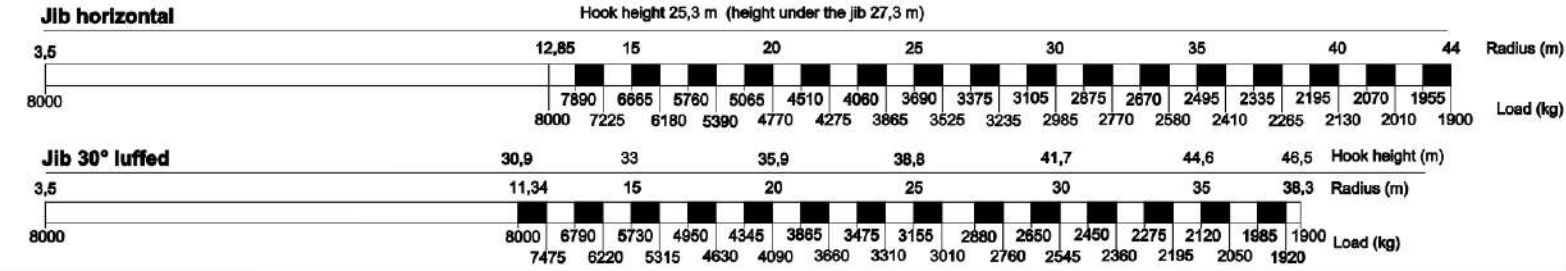

LIFTING CHART outrigger support base 6,925 m x 5,15 m up to wind force 8 on the Beaufort scale (17 m/sec)

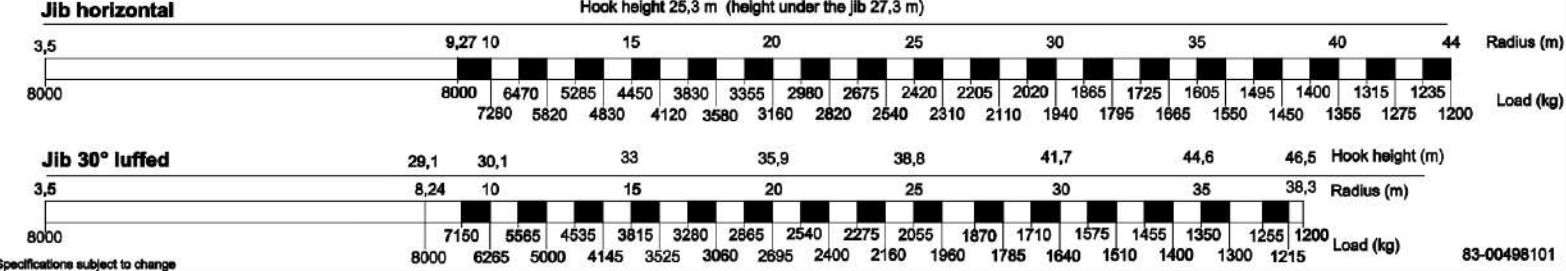

Specifications subject to change

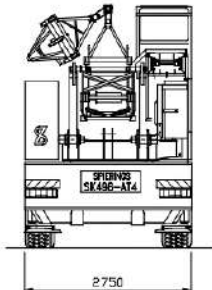
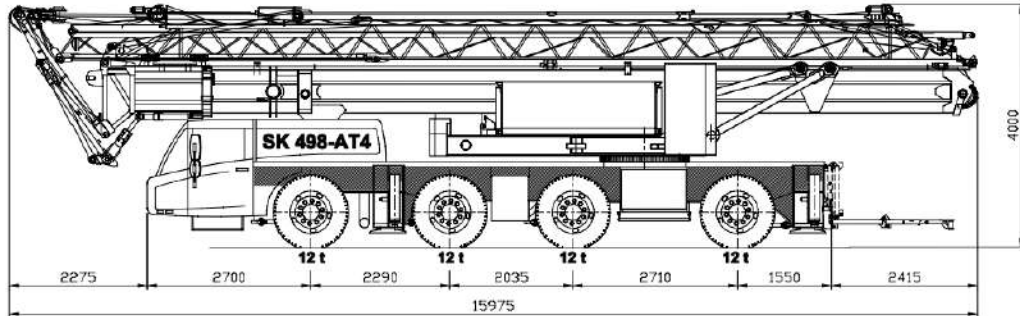
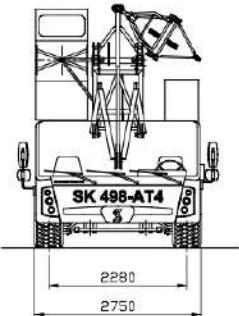
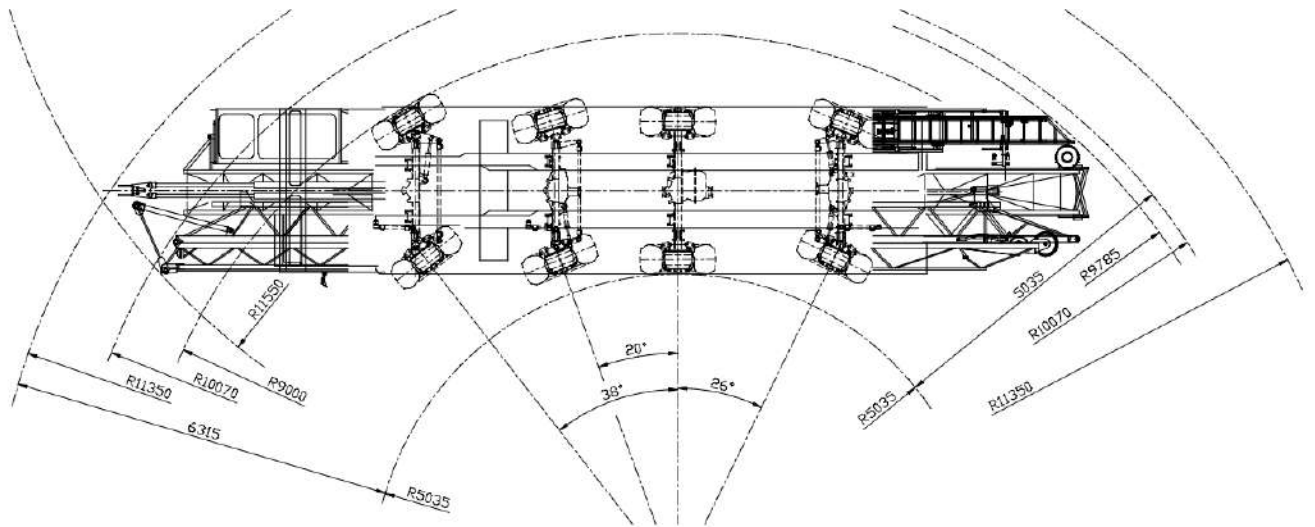

SPIERINGS HYDRAULIC FOLDING CRANE

SK 498 - AT4

SPIERINGS
MOBILE CRANES

Merwedestraat 15
5347 KZ Oss NL
Tel. +31 (0)412-626964
Fax. +31 (0)412-645298
www.spieringscranes.com

83-00498102

Overall weight: 48000 kg

Specifications subject to change

SPIERINGS
HYDRAULIC FOLDING CRANE
SK498-AT4

498xxx

Erection procedure of the crane

Max. outrigger force : 360 kN
 Outrigger support pads : 750x600 mm
 Ground pressure : 0,80 N/mm²
 Jib can be unfolded through 360°
 Luffing the jib 30° can be controlled from
 the crane cab or remote control

Outrigger support plates : 1100x1100 mm
 surface : 1,21 m²
 Ground pressure : 0,30 N/mm²

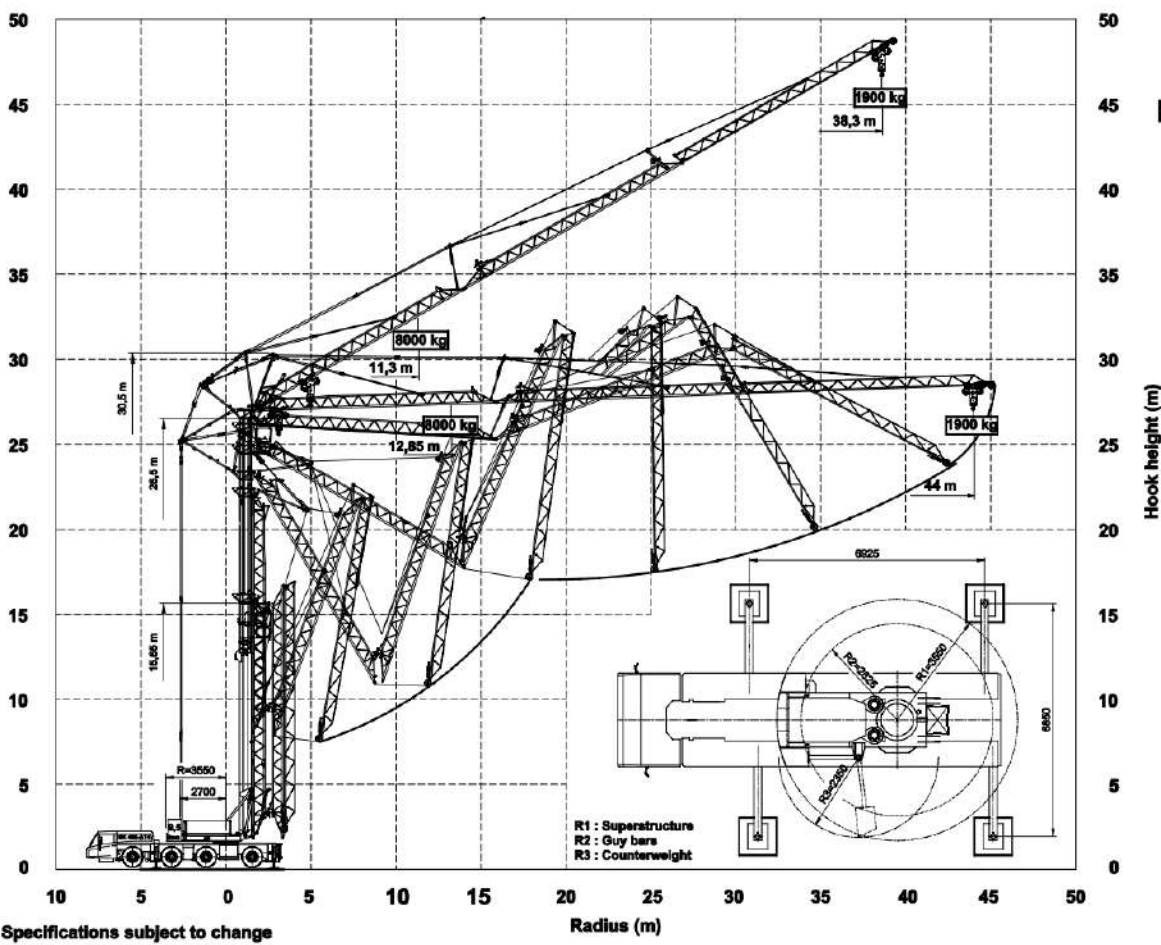

Specifications subject to change



Merwedestraat 15
 5347 KZ Oss NL
 Tel. +31 (0)412-626964
 Fax +31 (0)412-645299
 www.spieringcranes.com

83-00498103

SPIERINGS
HYDRAULIC FOLDING CRANE
SK 498 - AT4

498xxx

Hoisting Specifications
Outrigger support base
6,925 m x 6,85 m

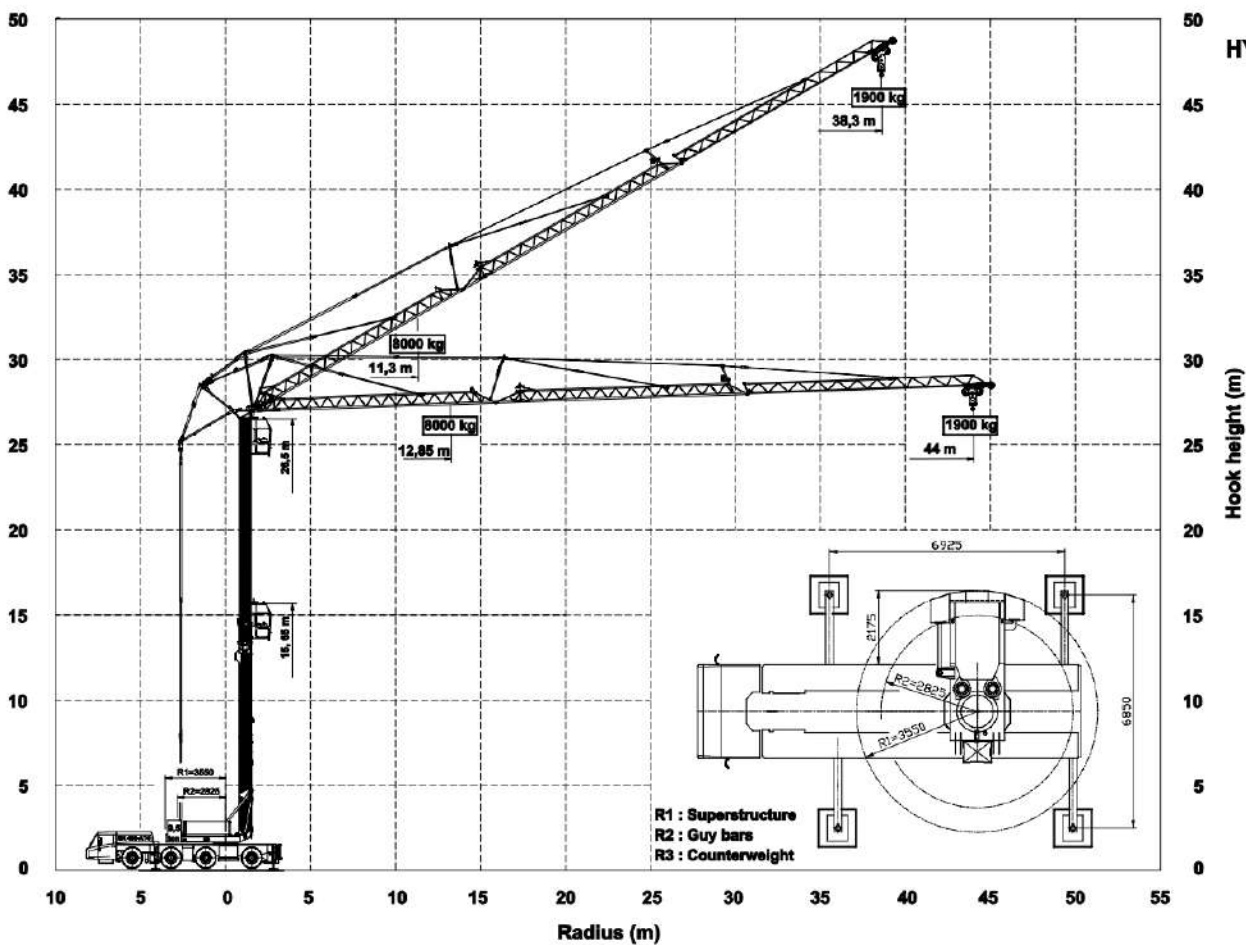

SPIERINGS
MOBILE CRANES

Merwedestraat 15
 5347 KZ Oss NL
 Tel. +31 (0)412-626964
 Fax +31 (0)412-645299
 www.spieringscranes.com

83-00488104

Specifications subject to change

SPIERINGS
HYDRAULIC FOLDING CRANE
SK 498 - AT4

498xxx

Hoisting Specifications
Outrigger support base
6,925 m x 5,15 m

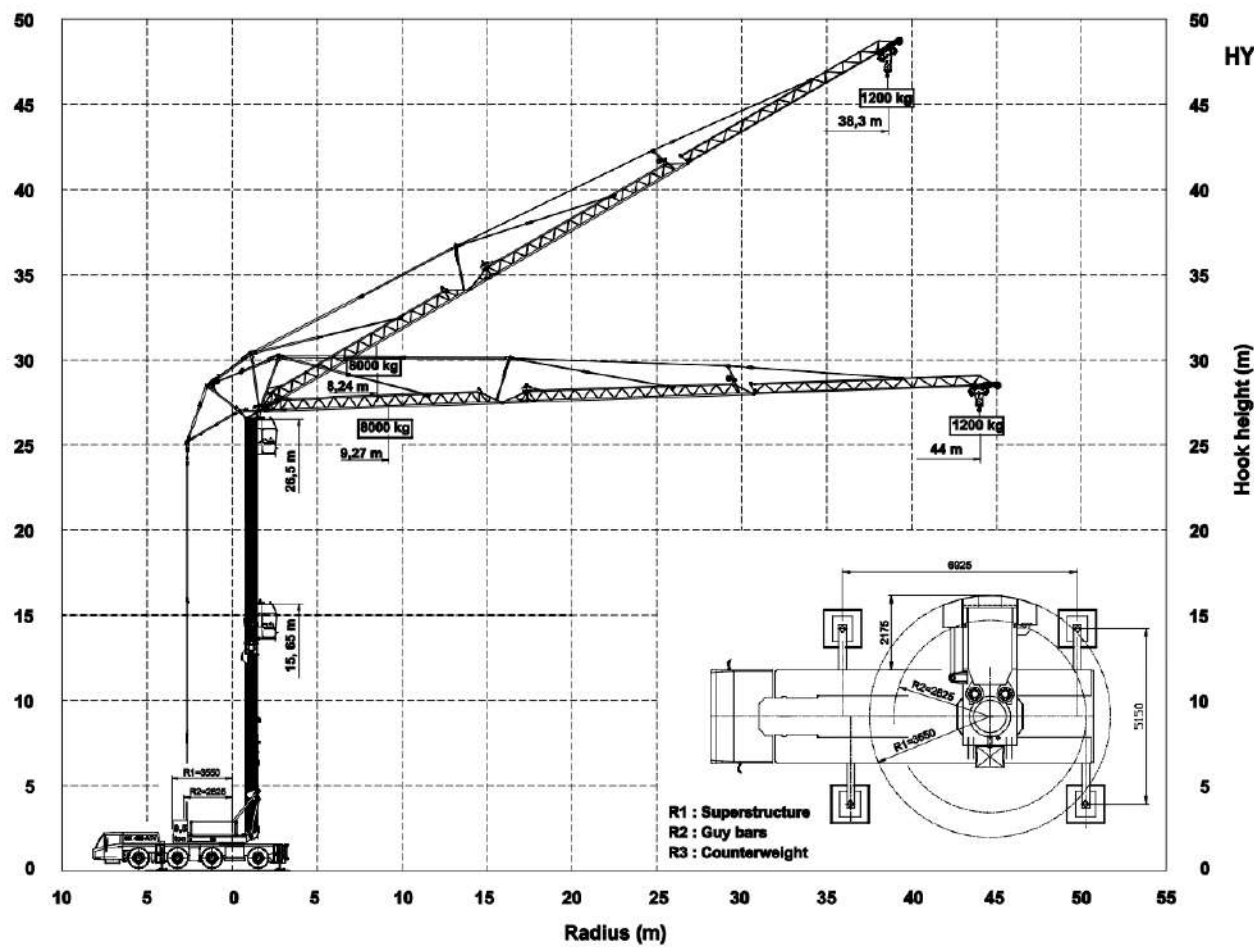

SPIERINGS
MOBILE CRANES

Merwedestraat 15
 5347 KZ Oss NL
 Tel. +31 (0)412-628964
 Fax +31 (0)412-645299
 www.spierscranes.com

83-00498105

Specifications subject to change

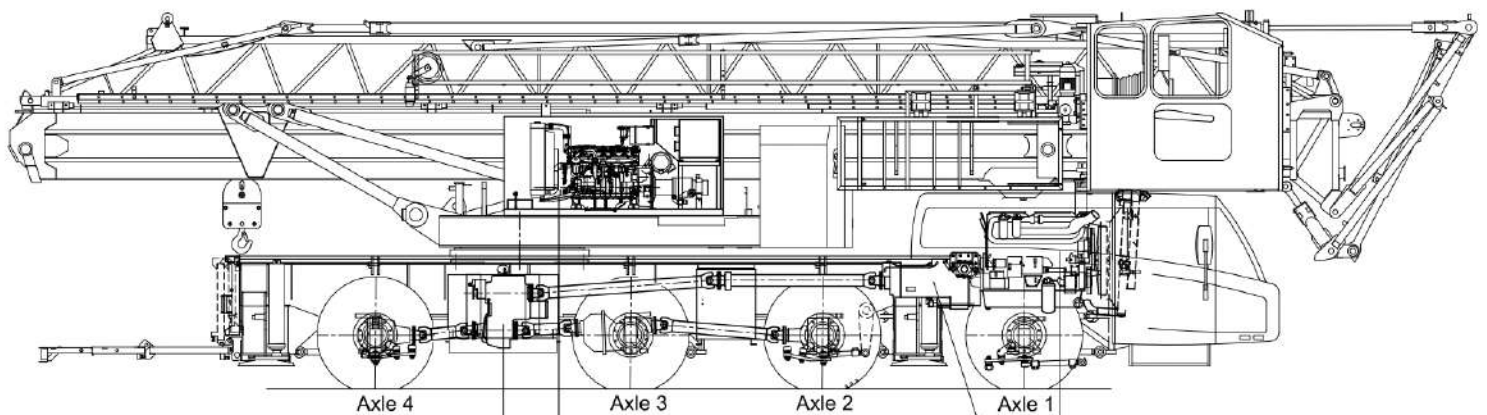

Transferbox
 STEYR VG2001/396
 Road gear $i=0,89$
 Off road gear $i=1,54$

Superstructure:
 John Deere: 4045HF285-T3
 Power: 104 kW (2400 rpm)
 Torque: 387 Nm (1500 rpm)

Gearbox:
 ZF 12AS2300
 Automatic
 + Intarder

Carrier Diesel Engine :
 Euro IV
 DAF: MX 300 (12,9 ltr)
 Power: 300 kW (1900 rpm)
 Torque: 2050 Nm (1500 rpm)

Axle 1 :Steer axle
 Axle 2 :Steer axle, driven (end reduction $i=7,29$)
 Axle 3 :Driven (end reduction $i=7,29$)
 Axle 4 :Steer axle, driven (end reduction $i=7,29$)

Tyres : 445/75 R22,5
 Suspension: hydro-pneumatic on all axles, stroke cyl. : 247 mm
 Max. speed carrier : 82 km/h
 Min. speed carrier (diesel engine 1000 rpm) : 1,6 km/h
 Overall weight : 48.000 kg.

DRIVE TRAIN SPIERINGS FOLDING CRANE SK498-AT4

SPIERINGS
MOBILE CRANES

Merwedestraat 15
 5347 KZ Oss NL
 Tel. +31 (0)412-626964
 Fax +31 (0)412-645299
 www.spieringscranes.com

83-00498106A

SPIERINGS
HYDRAULIC FOLDING CRANE
SK 498 - AT4

498xxx

Overzicht afstempeling

Max. outrigger force	360 kN
Outrigger support pads	750x600 mm
Ground pressure	0,80 N/mm ²
Outrigger support plates	1100x1100 mm
Surface	1,21 m ²
Ground pressure	0,30 N/mm ²

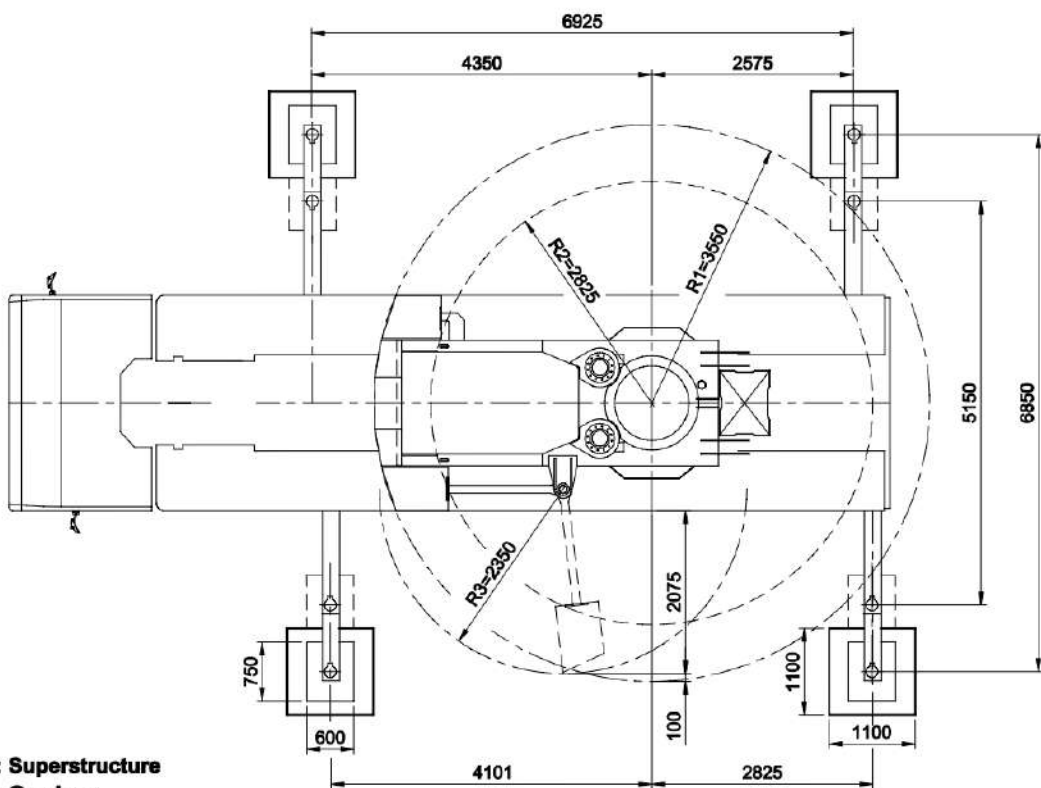

- R1 : Superstructure**
- R2 : Guy bars**
- R3 : Counterweight**



Merwedestraat 15
 5347 KZ Oss NL
 Tel. +31 (0)412-626064
 Fax +31 (0)412-645299
www.spieringscranes.com

83-00498107

Specifications subject to change